

PAPER ROCKET

Print and build your own paper Rocket.

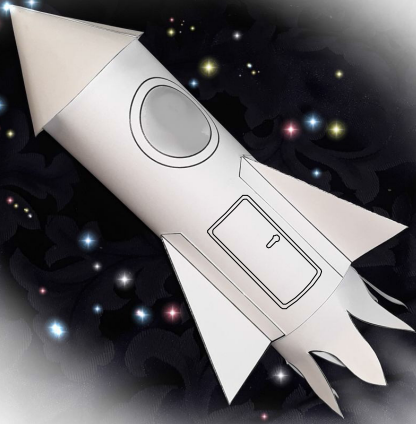

You will Need:

- *Scissors or Craft knife.
- *Glue stick or PVA Glue
- *A Black pen or a pencil.
- *A Ruler

1. Cut around each piece.
2. Score the fold lines with the pen/pencil and ruler.
3. Fold along lines.
4. Assemble rocket body first.
5. Assemble fins last.

Tips and ideas

- *Print on 160 gsm Card
- *You can colour in your rocket before cutting or print it on coloured card.
- *Draw an astronaut looking out of the windows or use a photo of you, your friends or pets.

Flames

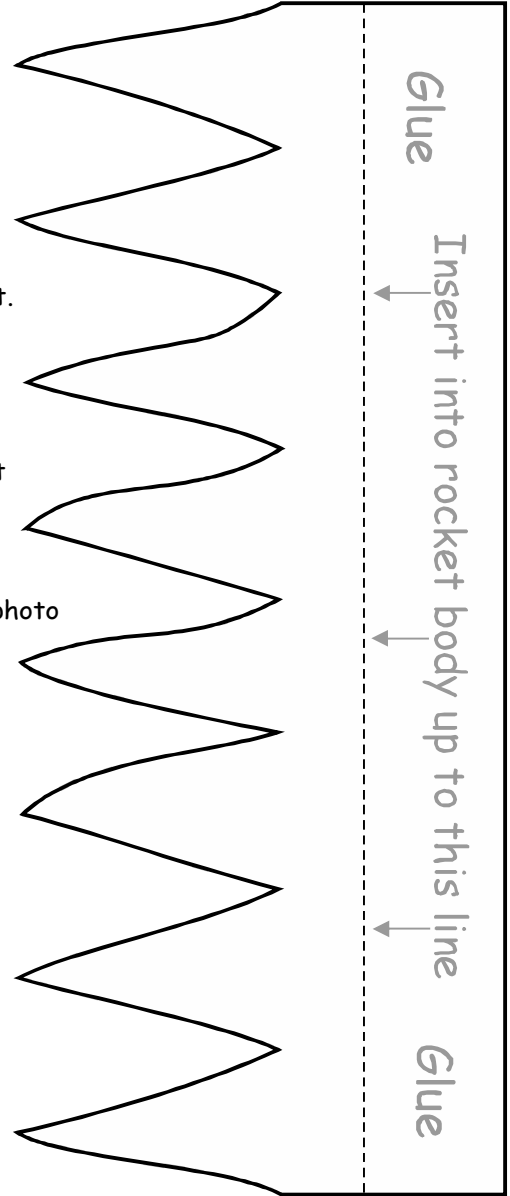

Nose Cone

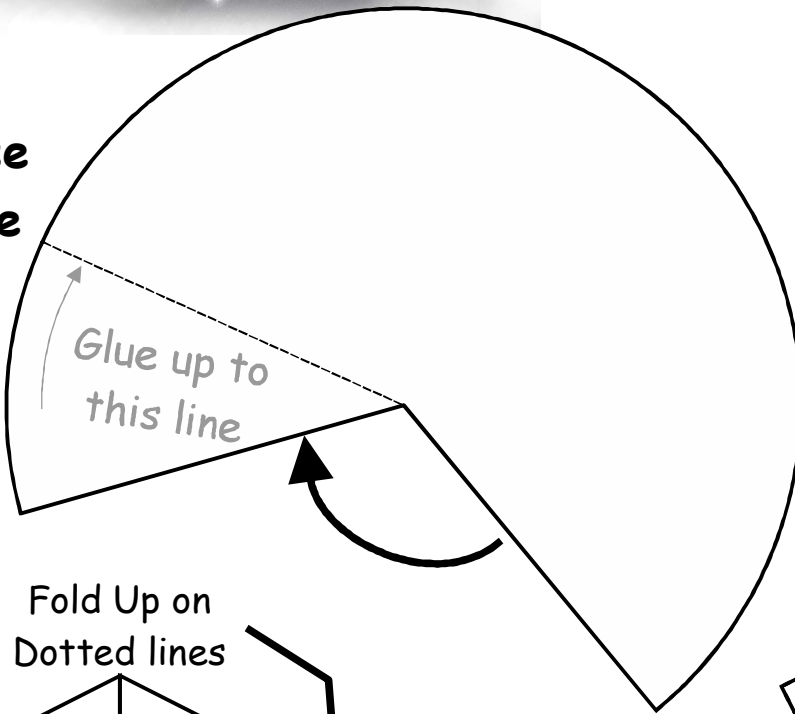

Fold Up on Dotted lines

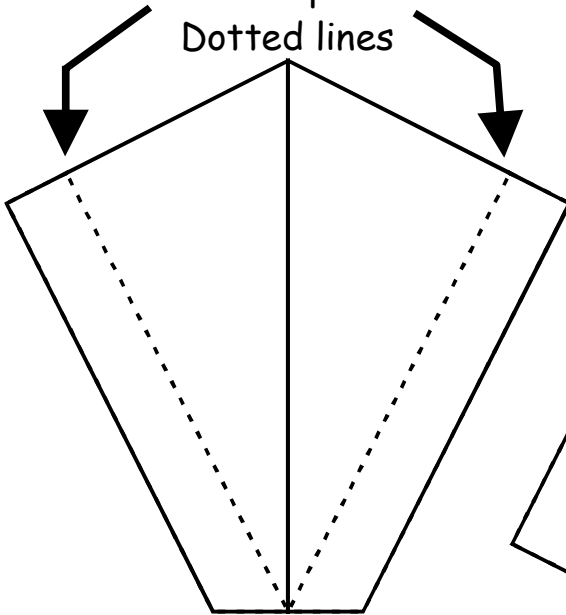

Fold Down on centre line

Fins x 3

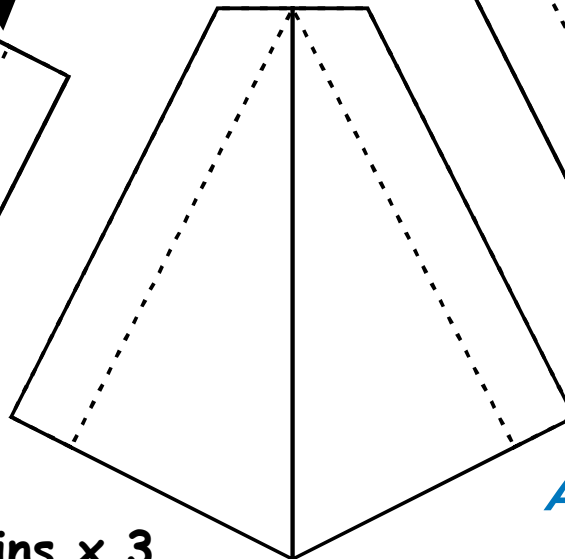

AIR FORCE MUSEUM
of New Zealand

**DISCOVER
ENGAGE
REFLECT**

Instructions

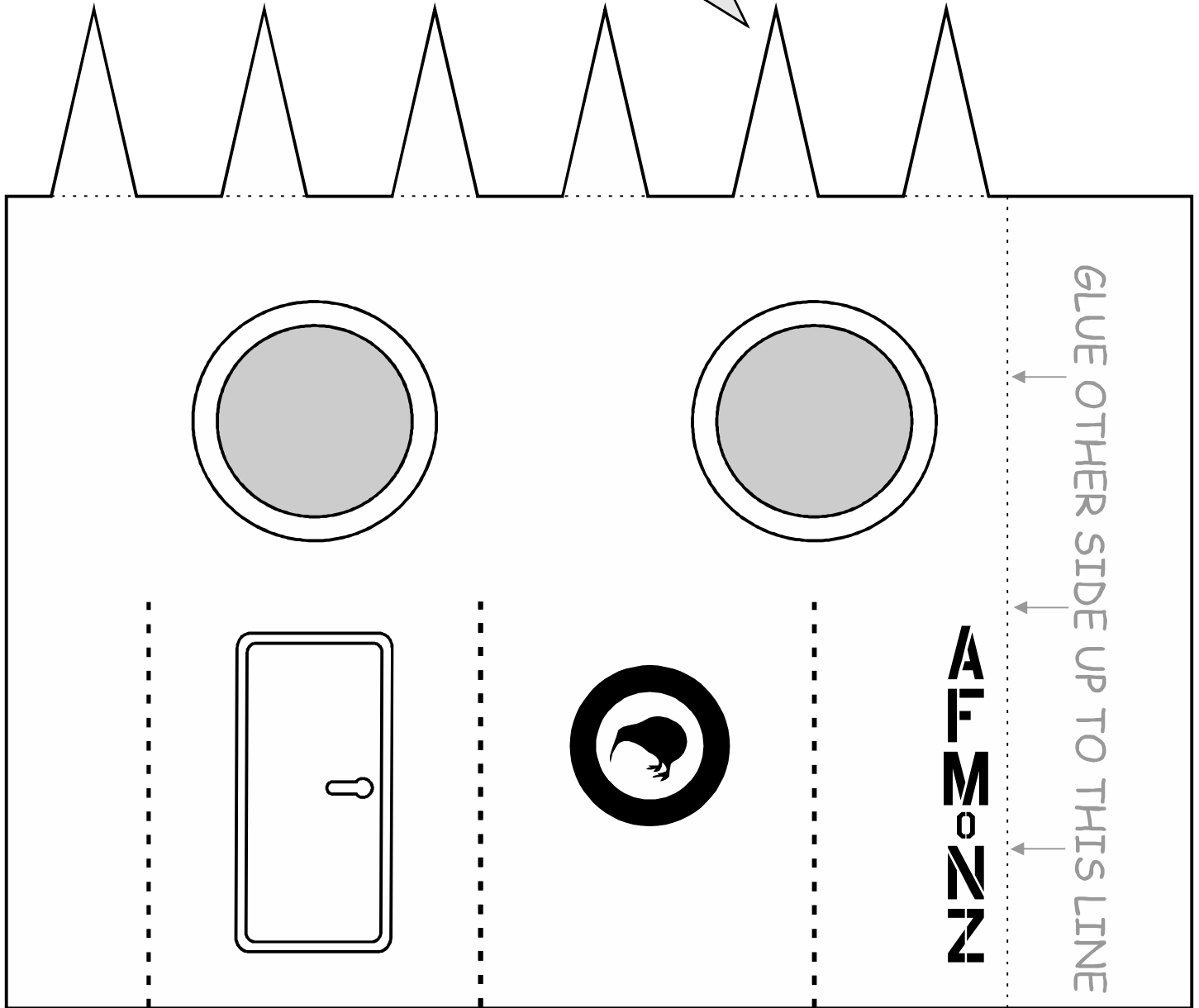
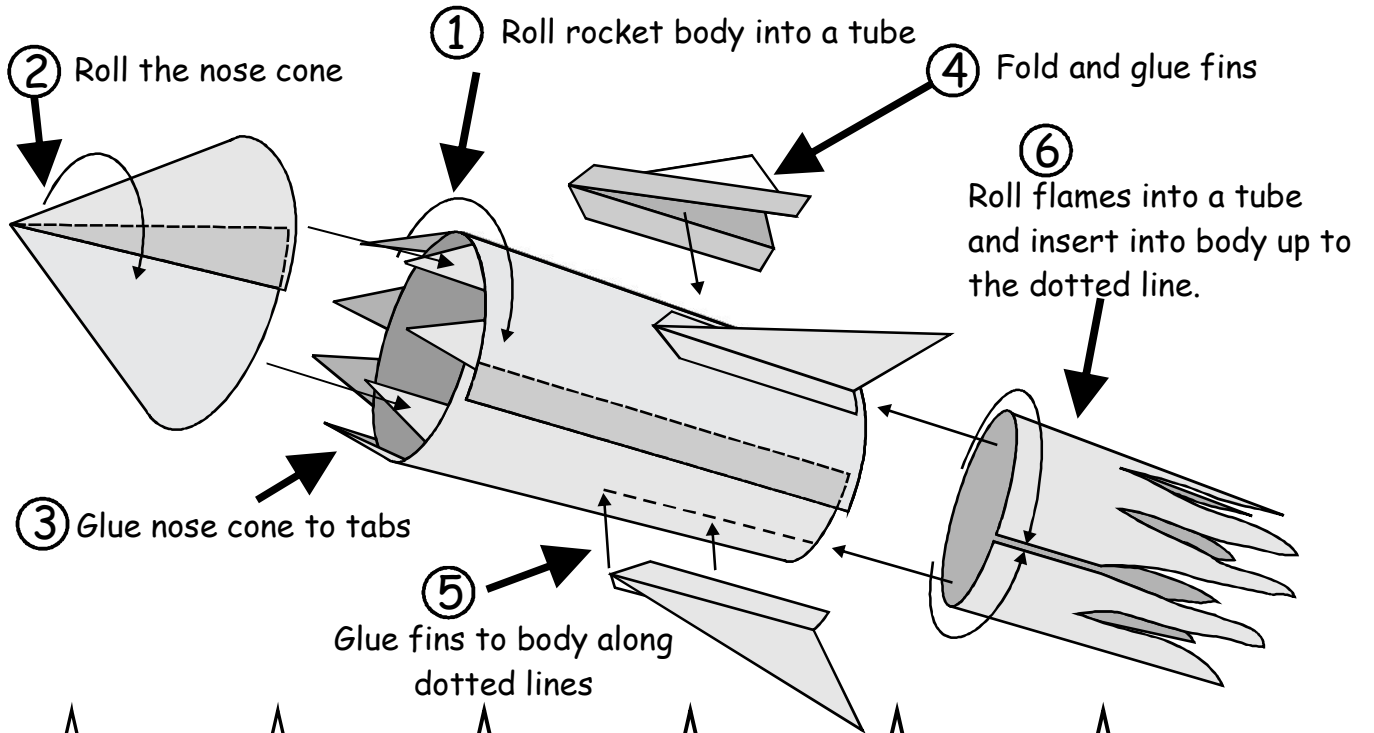

GLUE FINS ON THESE LINES

Rocket Body